





Suspension posts US and STS

Multipurpose suspension posts designed to connect working tools Ostraticky with tractor or another carrier. Including hydraulic hoses and quick couplings, hoses length up to 250 cm.

suspension post US		order no.	
	suspension post US - lift 60 cm - height 165 cm	SLOUPUS0	
	suspension post US, fixed - with mounting flange - height 165 cm	SLOUPUSP	
	carrying arm US-M32M - mechanical side shift 32 cm, mechanical tilting +18°/-18°	RAMUSM32M	
	carrying arm US-M32H - mechanical side shift 32 cm, hydraulic tilting +21°/-21°	RAMUSM32H	
	carrying arm US-M60M - mechanical side shift 60 cm, mechanical tilting +18°/-18°	RAMUSM60M	
	carrying arm US-M60H - mechanical side shift 60 cm, hydraulic tilting +21°/-21°	RAMUSM60H	
	carrying arm US-H32M - hydraulic side shift 32 cm, mechanical tilting +18°/-18°	RAMUSH32M	
	carrying arm US-H32H - hydraulic side shift 32 cm, hydraulic tilting +21°/-21°	RAMUSH32H	
	carrying arm US-H40M - hydraulic side shift 40 cm, mechanical tilting +18°/-18°	RAMUSH40M	
	carrying arm US-H40H - hydraulic side shift 40 cm, hydraulic tilting +21°/-21°	RAMUSH40H	
	carrying arm extended US-H4PM - hydraulic side shift 40 cm, mechanical tilting +18°/-18°	RAMUSH4PM	
	carrying arm extended US-H4PH - hydraulic side shift 40 cm, hydraulic tilting +21°/-21°	RAMUSH4PH	
	set of carrying arms US2X-H32M - hydraulic side shift 32 cm, mechanical tilting +18°/-18°	RAMUS2XH32M	
	set of carrying arms US2X-H32H - hydraulic side shift 32 cm, hydraulic tilting +21°/-21°	RAMUS2XH32H	
	set of carrying arms US2X-H40M - hydraulic side shift 40 cm, mechanical tilting +18°/-18°	RAMUS2XH40M	
	set of carrying arms US2X-H40H - hydraulic side shift 40 cm, hydraulic tilting +21°/-21°	RAMUS2XH40H	

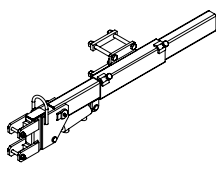
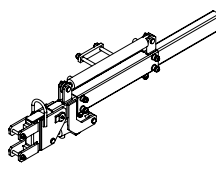
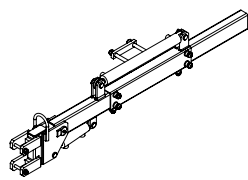
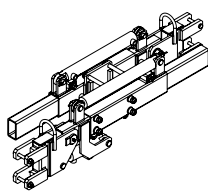
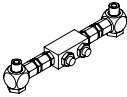
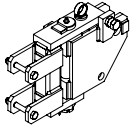
	pilot operated check valve of tilting cylinder <i>(for carrying arms US)</i>	ZAMEKNAKLUS	
	fork US, hinged <i>(instead of fixed)</i>	SKLMPEV	

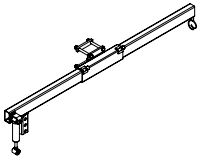
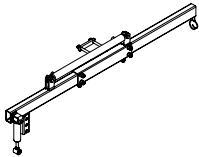
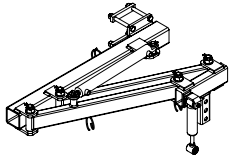
suspension post STS		order no.	
	suspension post STS-M <i>- mechanical tilting +25°/-18°</i>	shortened <i>(lift 60 cm, height 166 cm)</i>	SLOUPSTS06ZM
		standard <i>(lift 60 cm, height 204 cm)</i>	SLOUPSTS060M
		extended lift <i>(lift 100 cm, height 212 cm)</i>	SLOUPSTS100M
	suspension post STS-H <i>- hydraulic tilting +25°/-20° - including pilot operated check valve of tilting cylinder</i>	shortened <i>(lift 60 cm, height 166 cm)</i>	SLOUPSTS06ZH
		standard <i>(lift 60 cm, height 204 cm)</i>	SLOUPSTS060H
		extended lift <i>(lift 100 cm, height 212 cm)</i>	SLOUPSTS100H
	carrying arm STS-M <i>- mechanical side shift 72 cm - including shock absorber</i>	RAMSTSM	
	carrying arm STS-H26 <i>- hydraulic side shift 60 cm, distance from centre of the post 78 cm - including shock absorber</i>	RAMSTSH26	
	carrying arm STS-H46 <i>- hydraulic side shift 60 cm, distance from centre of the post 98 cm - including shock absorber</i>	RAMSTSH46	
	carrying arm with parallelogram side shift STS-P <i>- hydraulic side shift 136 cm - including shock absorber</i>	RAMSTSP	

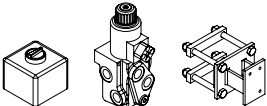
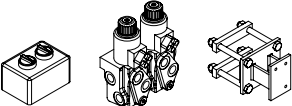
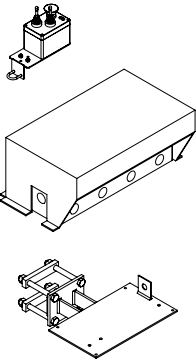
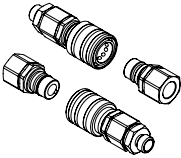
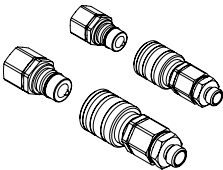
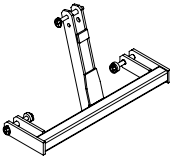
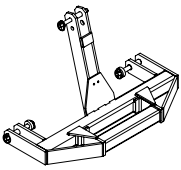
supplements and accessories		order no.	
	hydraulic diverging, built-in <i>(control of 2 functions by 1 hydraulic circuit)</i>	HYDRVESTUS	
	hydraulic diverging ECO, built-in <i>(control of 3 functions by 1 hydraulic circuit)</i>	HYDRECOUS	
	hydraulic control valves, electric operated, built-in	3x double-acting	HYDRE30VESTUS
		4x double-acting	HYDRE40VESTUS
		5x double-acting	HYDRE50VESTUS
		6x double-acting	HYDRE60VESTUS
		7x double-acting	HYDRE70VESTUS
		2x double-acting, 1x single-acting	HYDRE21VESTUS
		3x double-acting, 1x single-acting	HYDRE31VESTUS
		4x double-acting, 1x single-acting	HYDRE41VESTUS
		5x double-acting, 1x single-acting	HYDRE51VESTUS
		6x double-acting, 1x single-acting	HYDRE61VESTUS
	set of quick couplings, basic <i>(2x js12,5)</i>	RYCHSAD020Z	
	set of quick couplings, basic <i>(1x js12,5, 1x js20)</i>	RYCHSAD011Z	
	frame for 3-point linkage TBZ11-US <i>(for front 3-point linkage cat. 1/2 by ISO 730-1)</i>	TBZ11US	
	frame for 3-point linkage TBZ11-STS <i>(for front 3-point linkage cat. 1/2 by ISO 730-1)</i>	TBZ11STS	

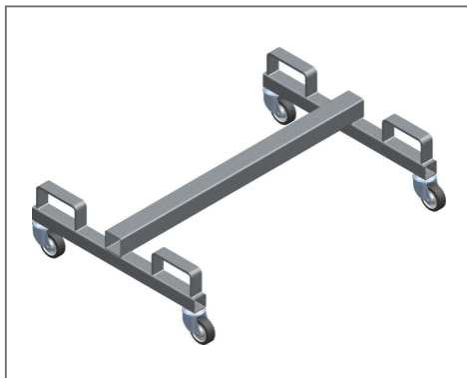

Storing stands with wheels

For storage of equipment after season, dimension 120x80 cm, 2 fixed and 2 swivel wheels with brake, various design according to type of machine.

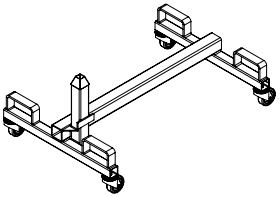
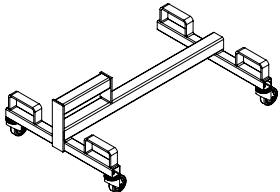
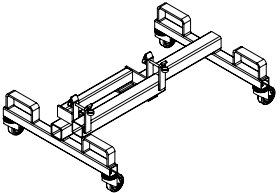
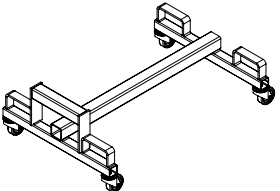
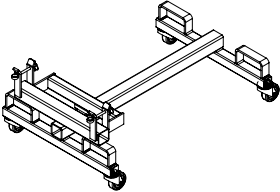
storing stands with wheels		order no.	
	<p>storing stand US</p> <p>- all machines on the suspension post US, also connected by TBZ11-US</p> <p>- PN1, PN2, ST, EF, PRO, PNP, etc.</p>	CS669.201000	
	<p>storing stand PNP</p> <p>- side-mounted machines on suspension post STS</p> <p>- especially for PNP, STS</p>	CS669.202000	
	<p>storing stand PNP/TBZ</p> <p>- side-mounted machines on suspension post STS connected by TBZ11-STZ</p> <p>- especially for PNP, STS</p>	CS669.203000	
	<p>storing stand STS</p> <p>- trimmer STS and another machines with carrying arm with parallelogram RAMSTSP</p>	CS669.204000	
	<p>storing stand STS/TBZ</p> <p>- trimmer STS and another machines with carrying arm with parallelogram RAMSTSP, connected by TBZ11-STZ</p>	CS669.205000	