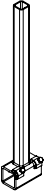
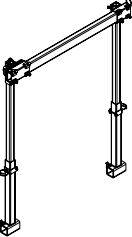
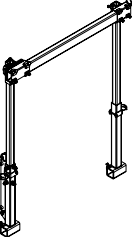
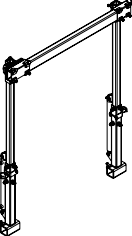
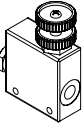
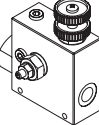
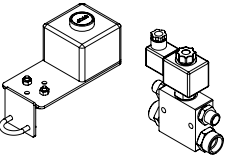

## Vine stem cleaners for vineyards Duplex I

Suckering tools for mechanization of cleaning stems of vine from unwanted shoots and old rind, diameter of the brush is 45 cm, working height 40 cm or 60 cm. Including hydraulic hoses and quick couplings, hoses length up to 150 cm for side suspension, up to 250 cm for front suspension.

one-sided machine - for side, front or rear suspension		order no.	
	Duplex 45/40 PR <i>(right-sided)</i>	<b>DUPLEX4540PR</b>	
	Duplex 45/40 PL <i>(left-sided)</i>	<b>DUPLEX4540PL</b>	
	Duplex 45/60 PR <i>(right-sided)</i>	<b>DUPLEX4560PR</b>	
	Duplex 45/60 PL <i>(left-sided)</i>	<b>DUPLEX4560PL</b>	

supplements and accessories		order no.	
	adjustable tracer <i>(including holder)</i>	right-sided	<b>CS411.912VYS</b>
		left-sided	<b>CS412.912VYS</b>
	vine stem cleaner bracket 01 <i>(for suspension 01E, 01S)</i>	<b>CS410.901000</b>	
	vine stem cleaner bracket 02 <i>(for suspension 02E, 02S)</i>	<b>CS410.902000</b>	
	vine stem cleaner holder 03 <i>(vertical, for suspension 03, 04, 03m, 04m, length 40 cm, parts set)</i>	<b>CS410.903000</b>	

	<p>vine stem cleaner holder US <i>(vertical, for carrying arm US, length 75 cm)</i></p>	<p><b>CS410.904000</b></p>	
	<p>suspension BasicD-M <i>- mechanical height adjustment of carrying arms - angle adjustment of the vertical arms</i></p>	<p><b>BASICDUSM</b></p>	
	<p>suspension BasicD-H1 <i>- hydraulic height adjustment of the outer carrying arm - angle adjustment of the vertical arms</i></p>	<p>right-sided</p>	<p><b>BASICDUSH1R</b></p>
		<p>left-sided</p>	<p><b>BASICDUSH1L</b></p>
	<p>suspension BasicD-H2 <i>- hydraulic height adjustment of both carrying arms - angle adjustment of the vertical arms</i></p>	<p><b>BASICDUSH2</b></p>	
	<p>oil flow control valve 01</p>	<p><b>DEL01</b></p>	
	<p>oil flow control valve 03</p>	<p><b>DEL03</b></p>	
	<p>electric operated STOP-button</p>	<p><b>STOPTL1T</b></p>	

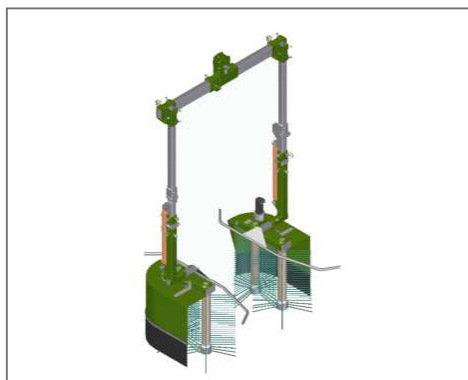

## Vine stem cleaners for vineyards Duplex II

Suckering tools for mechanization of cleaning stems of vine from unwanted shoots and old rind, diameter of the brush is 45 cm, working height 40 cm or 60 cm. Including hydraulic hoses and quick couplings, hoses length up to 250 cm. Over-row machines, for suspension on STS carrying arm.

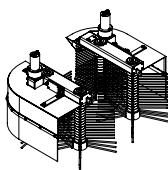
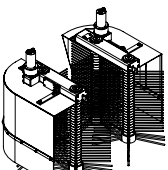
over-row machine		order no.
	Duplex 45/40 PTS, over-row	<b>DUPLEX4540PTS</b>
	Duplex 45/60 PTS, over-row	<b>DUPLEX4560PTS</b>

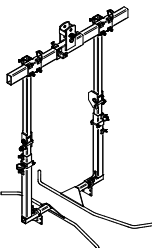
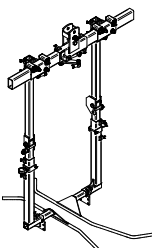
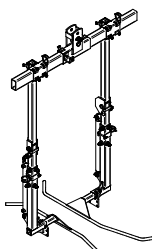
supplements and accessories		order no.
	suspension BasicD-STSM0M - mechanical height adjustment of carrying arms - mechanical width adjustment - fixed brackets of the vertical arms	<b>BASICDSTSM0M</b>
	suspension BasicD-STSM0H - mechanical height adjustment of carrying arms - hydraulic width adjustment - fixed brackets of the vertical arms	<b>BASICDSTSM0H</b>
	suspension BasicD-STSH2M - hydraulic height adjustment of both carrying arms - mechanical width adjustment - fixed brackets of the vertical arms	<b>BASICDSTSH2M</b>

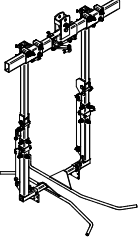
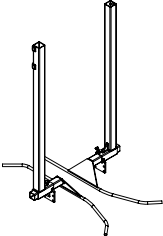
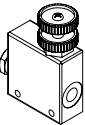
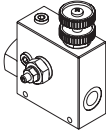
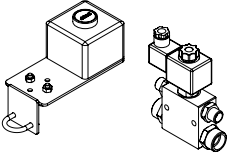
	<p>suspension BasicD-STSH2H          - hydraulic height adjustment of both carrying arms          - hydraulic width adjustment          - fixed brackets of the vertical arms</p>	<p><b>BASICDSTSH2H</b></p>	
	<p>vertical arms          (for suspending on vine trimmer STS)</p>	<p><b>CS323.033000</b></p>	
	<p>oil flow control valve 01</p>	<p><b>DEL01</b></p>	
	<p>oil flow control valve 03</p>	<p><b>DEL03</b></p>	
	<p>electric operated STOP-button</p>	<p><b>STOPTL1T</b></p>	