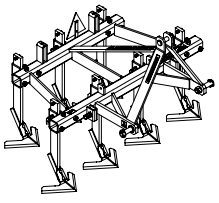
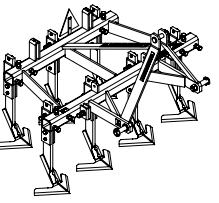
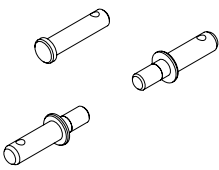
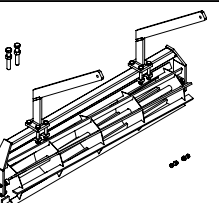
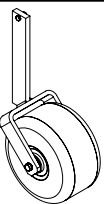
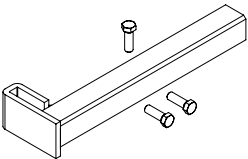
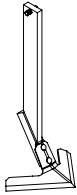
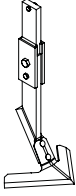
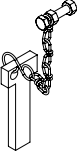
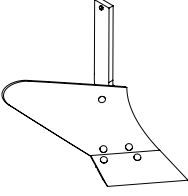
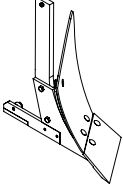

## Cultivators for vineyards and orchards

Cultivators for cultivation and weed control in vineyards, orchards, hopgardens and nurseries all the year round, equipped by multipurpose frame for mounting additional equipment, duck-foot shaped share wide 28 cm. Suspension pins cat. 2, possible optional exchange for pins cat. 1 by ISO 730-1.

cultivators	working width	number of tines	suspension	order no.	
	136 cm	7 / fixed	cat. 2 (1)	<b>UP130P</b>	
	172cm	9 / fixed	cat. 2 (1)	<b>UP165P</b>	
	208 cm	11 / fixed	cat. 2	<b>UP200P</b>	
	244 cm	13 / fixed	cat. 2	<b>UP240P</b>	
	136 cm	7 / with shear bolt	cat. 2 (1)	<b>UP130J</b>	
	172 cm	9 / with shear bolt	cat. 2 (1)	<b>UP165J</b>	
	208 cm	11 / with shear bolt	cat. 2	<b>UP200J</b>	
	244 cm	13 / with shear bolt	cat. 2	<b>UP240J</b>	

light cultivators		order no.	
	pins set for suspension cat. 1 <i>(exchange for pins cat. 2)</i>	<b>UPCEPKAT1</b>	
	crushing roller for UP130x, (d300 mm, w120/126 cm)	<b>CS111.300002</b>	
	crushing roller for UP165x, (d300 mm, w154/160 cm)	<b>CS111.400002</b>	
	crushing roller for UP200x, (d300 mm, w190/197 cm)	<b>CS111.500002</b>	
	crushing roller for UP240x, (d300 mm, w226/233 cm)	<b>CS111.600002</b>	
	supporting wheel, metallic, d250, with bent tine <i>(tine 50x16)</i>	<b>CS125.922000</b>	
	holder of the tine with duck-foot shaped share / ploughshare 60x60, l=500 <i>(for tine 70x20)</i>	<b>CS112.901000</b>	

	tine 60x20 with duck-foot shaped share 280, fixed tine	<b>CS123.020R28</b>	
	tine 60x20 with duck-foot shaped share 280, tine with shear bolt	<b>CS111.300063</b>	
	spacing pin 10x20 with chain	<b>CS123.020910</b>	
	plough for ploughing towards, right (tine 70x20)	<b>CS123.061000</b>	
	plough for ploughing towards, left (tine 70x20)	<b>CS123.062000</b>	

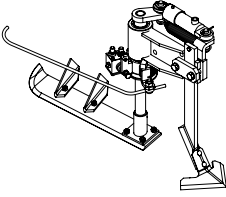
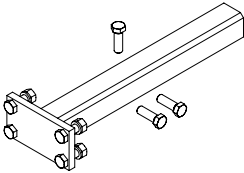
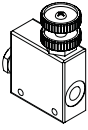
accessories		order no.	
	grape hoe, working tool 00E (other models 00E, see page 15) <b>Attention! It is necessary separate free-flow outlet to connect the equipment.</b>	<b>00E610RRR</b>	
	arm for mounting the grape hoe 60x60, l=500	<b>CS112.902000</b>	
	oil flow control valve 01	<b>DEL01</b>	

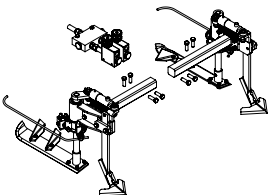
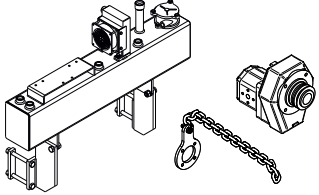
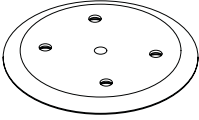
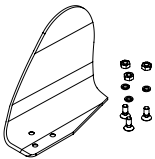

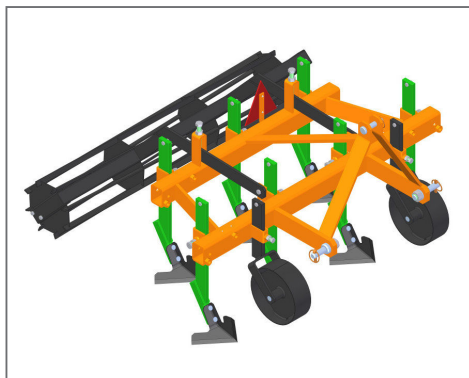
	<p>grape hoe - doublesided, for cultivator UP                  - working tools 00E61ORRR + 00E61LRR                  - arms for mounting the grape hoes on the cultivator, 2 pcs                  - hydraulic control system 06.11  <b>Attention! It is necessary separate free-flow outlet to connect the equipment.</b></p>		<p><b>UP06E610</b></p>		
	<p>hydraulic unit HAN 20.20 for cultivator UP                  - with oil cooler and return filter, oil reserve 20 l                  - oil flow 20 l/min / 540 rpm                  - pump PTO shaft 1 3/8" - 6</p>		<p><b>HAN2020UP</b></p>		
	<p>knife foot</p>		<p><b>CS121.090140</b></p>		
	<p>moldboard for cultivation knife, h=14 cm                  (including fasteners and mounting on the knife)</p>		<p>right-sided</p>	<p><b>CS121.ODHRN14VR</b></p>	
			<p>left-sided</p>	<p><b>CS121.ODHRN14VL</b></p>	

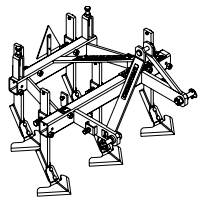
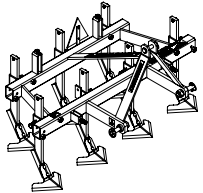

## Light cultivators for compact tractors

The light cultivators for cultivation and weed control in vineyards, orchards, hopgardens and nurseries all the year round, equipped by multipurpose frame for mounting additional equipment, special design for compact tractors, duck-foot shaped share wide 22 cm. Standard hitch of cat. 1N by ISO 730-2.

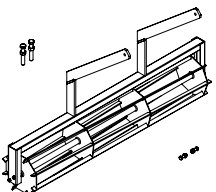
light cultivators		order no.	
	<p>Cultivator for compact tractor UP-095N1</p> <ul style="list-style-type: none"> <li>- working width 97 cm</li> <li>- 5 fixed tines with duck-foot shaped share, w22 cm</li> </ul>	<b>UP095N1</b>	
	<p>Cultivator for compact tractor UP-125N1</p> <ul style="list-style-type: none"> <li>- working width 130 cm</li> <li>- 7 fixed tines with duck foot shaped share, w22 cm</li> </ul>	<b>UP125N1</b>	

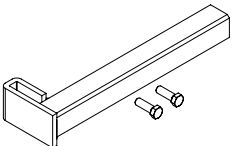
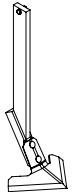
supplements		order no.	
	crushing roller for UP-095N1, (d220 mm, w88/95 cm)	<b>CS111.010004</b>	
	crushing roller for UP-125N1, (d220 mm, w118/126 cm)	<b>CS111.200004</b>	
	<p>supporting wheel, metallic, d220, with bent tine</p> <p>(tine 50x16)</p>	<b>CS111.200003</b>	
	<p>holder of the tine with duck-foot shaped share / ploughshare</p> <p>67x48, l=500</p> <p>(for tine 70x20)</p>	<b>CS111.901000</b>	
	tine 50x16 with duck-foot shaped share 220	<b>CS123.0203MS</b>	

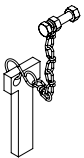
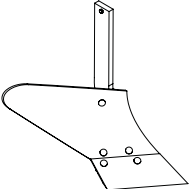
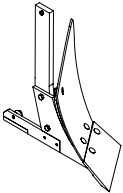
	<p>spacing pin 20x20 with chain</p>	<p><b>CS123.020920</b></p>	
	<p>plough for ploughing towards, right (tine 70x20)</p>	<p><b>CS123.061000</b></p>	
	<p>plough for ploughing towards, left (tine 70x20)</p>	<p><b>CS123.062000</b></p>	

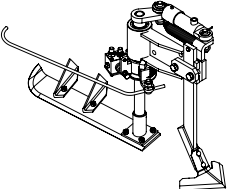
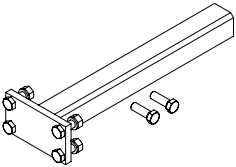
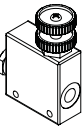
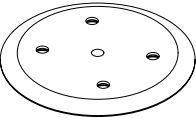
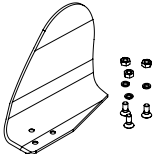
accessories	order no.		
	<p>grape hoe, working tool 00E (other models 00E, see page 15) <b>Attention! It is necessary separate free-flow outlet to connect the equipment.</b></p>	<p><b>00E51ORRR</b></p>	
	<p>arm for mounting the grape hoe 67x48, l=500</p>	<p><b>CS111.902000</b></p>	
	<p>oil flow control valve 01</p>	<p><b>DEL01</b></p>	
	<p>knife foot</p>	<p><b>CS121.090140</b></p>	
	<p>moldboard for cultivation knife, h=14 cm (including fasteners and mounting on the knife)</p>	<p><b>CS121.ODHRN14VR</b></p>	