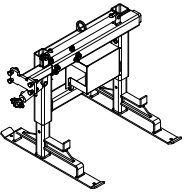
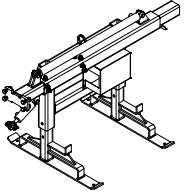
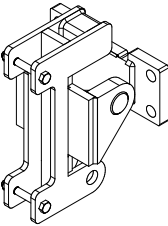
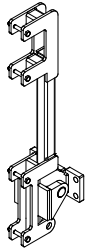
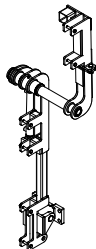

Pruning machines SL4-PNP

Pruning machines for tractor loaders or telescopic handlers with pruning bars PNP. Modified suspension SL4 with fork for mounting the pruning bars PNP. Including hydraulic hoses and quick couplings, hoses length up to 150 cm.

It is necessary to specify the exact type of carrier or the connection dimensions, when ordering.

suspension SL4-PNP		order no.	
	suspension SL4-PNP060 - right-sided - for tractor loaders - hydraulic side shift 60 cm - hydraulic tilting -5° / +15°	SL4PNP060000	
	suspension SL4-PNP100 - right-sided - for tractor loaders - hydraulic side shift 100 cm - hydraulic tilting -5° / +15°	SL4PNP100000	

pruning bars		order no.	
	fork for fastening pruning bars, simple	CS575.100310	
	fork for fastening pruning bars, doubled	CS575.100320	
	connecting part, turnable (0-90°)	with hydraulic tilting	CS575.10033H
		with mechanic tilting	CS575.10033M

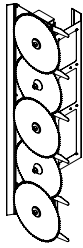
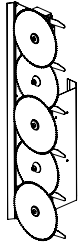
	PNP-050, vertical <i>(5 saw blades, working length 165 cm)</i>	PNP050R	
	PNP-040, vertical <i>(4 saw blades, working length 135 cm)</i>	PNP040R	
	PNP-500, upper <i>(5 saw blades, working length 165 cm)</i>	PNP500R	
	PNP-400, upper <i>(4 saw blades, working length 135 cm)</i>	PNP400R	
	PNP-300, upper <i>(3 saw blades, working length 100 cm)</i>	PNP300R	

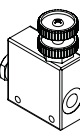
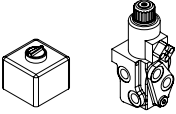
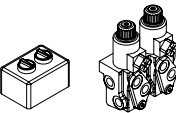
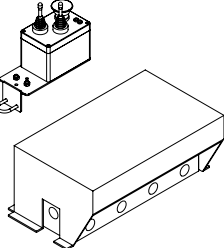
supplements and accessories		order no.	
	oil flow control valve 01	DEL01	
	hydraulic diverging, built-in <i>(control of 2 functions by 1 hydraulic circuit)</i>	HYDRVESTSL4	
	hydraulic diverging ECO, built-in <i>(control of 3 functions by 1 hydraulic circuit)</i>	HYDRECOSL4	
	hydraulic control valves, electric operated, modular	3x double-acting	HYDR30VESTSL4
		2x double-acting, 1x single-acting	HYDR21VESTSL4
		3x double-acting, 1x single-acting	HYDR31VESTSL4

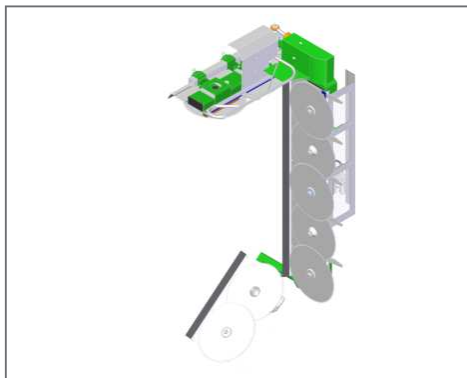

Pruning bars PNP

Special light pruning machines, intended especially for pruning of hedges or thinner branches up to 5 cm in orchards, saw blades d400 mm, 80 teeth, can be aggregated with US or STS posts, hoses length up to 250 cm.

It is necessary separate free-flow outlet to connect the equipment.

pruning bars PNP-xy0 - can be aggregated with US or STS posts		order no.	
	PNP-240 - 2-bars system (2+4) with independent drive - mechanical angle adjusting of the upper bar	PNP240R	
	PNP-250 - 2-bars system (2+5) with independent drive - mechanical angle adjusting of the upper bar	PNP250R	
	PNP-350 - 2-bars system (3+5) with independent drive - mechanical angle adjusting of the upper bar	PNP350R	

pruning bars PNP-xyz - it is necessary to be aggregated only with STS posts		order no.	
	PNP-252 - 3-bars system (2+5+2) with independent drive - mechanical angle adjusting of the upper and lower bar	PNP252R	
	PNP-253 - 3-bars system (2+5+3) with independent drive - mechanical angle adjusting of the upper and lower bar	PNP253R	
	PNP-254 - 3-bars system (2+5+4) with independent drive - mechanical angle adjusting of the upper and lower bar	PNP254R	
	PNP-255 - 3-bars system (2+5+5) with independent drive - mechanical angle adjusting of the upper and lower bar	PNP255R	
	PNP-352 - 3-bars system (3+5+2) with independent drive - mechanical angle adjusting of the upper and lower bar	PNP352R	
	PNP-353 - 3-bars system (3+5+3) with independent drive - mechanical angle adjusting of the upper and lower bar	PNP353R	
	PNP-354 - 3-bars system (3+5+4) with independent drive - mechanical angle adjusting of the upper and lower bar	PNP354R	
	PNP-355 - 3-bars system (3+5+5) with independent drive - mechanical angle adjusting of the upper and lower bar	PNP355R	

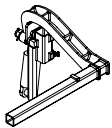
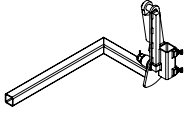
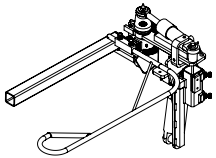
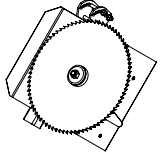
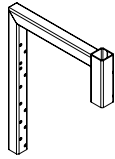
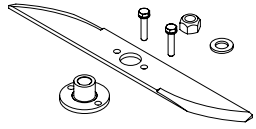
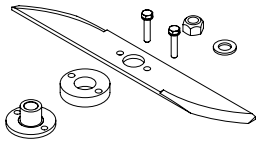
supplements and accessories			order no.	
	hydraulic angle adjusting of the upper bar	for 2R pruning bar	PNPNAKLHH22R	
		for 3R pruning bar	PNPNAKLHH23R	
	hydraulic angle adjusting of the lower bar	for 1R pruning bar	PNPNAKLDH11R	
		for 2R pruning bar	PNPNAKLDH12R	
		for 3R pruning bar	PNPNAKLDH13R	
	tracer controled back movement of the upper bar <i>(only for 2R bar, including hydraulic angle adjusting of the upper bar)</i> Attention! It is necessary to use two separate free-flow outlets to connect this equipment.		PNPAUTOHR	
	additional 1R pruning bar <i>(lower)</i>		PNP001R	
	L-frame for height adjusting the upper/lower bar	for upper bar	PNPLRAMH	
		for lower bar	PNPLRAMD	
	trimming knife, low set <i>(parts set for 1 rotor)</i>	steel knife	PNPSTDN01	
		stainless steel knife	PNPINOX01	
	trimming knife, high set <i>(parts set for 1 rotor)</i>	steel knife	PNPSTDN02	
		stainless steel knife	PNPINOX02	